

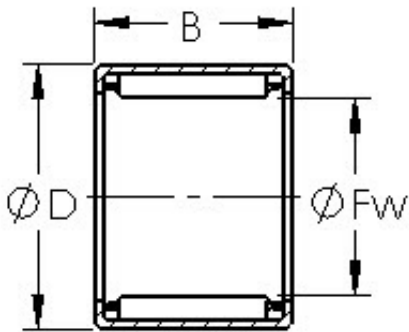

# Wuxi NSB Transmission Technology Co.,...



## AST HK1212 needle roller bearings

Bearing No. HK1212

Size	12x18x12 mm
Bore Diameter	12 mm
Outer Diameter	18 mm
Width	12 mm
Bearing Type	Cage Retained Rollers
Outer Dia (D)	18.0000
Width (B)	12.0000
Dynamic Load Rating (Cr)	6,500
Static Load Rating (Cor)	7,300
Max Speed (Grease) (X1000 RPM)	19,000
Shaft (Fw)	12.000
Weight (g)	9.00
Material - Drawn cup: Hardened carbon steel alloy, Rollers	52100 Chrome steel or equivalent

HK1212 Bearing 2D drawings and 3D CAD models